

April 1, 1960

Page 1

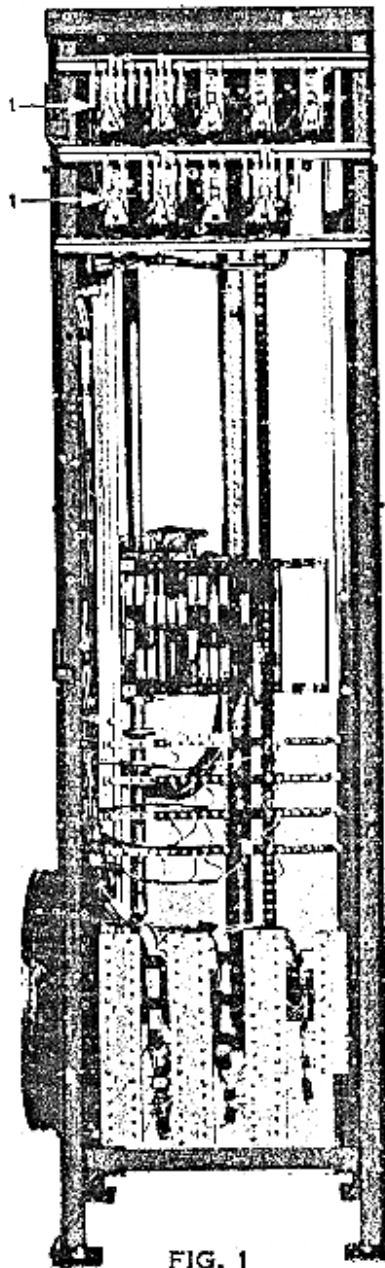
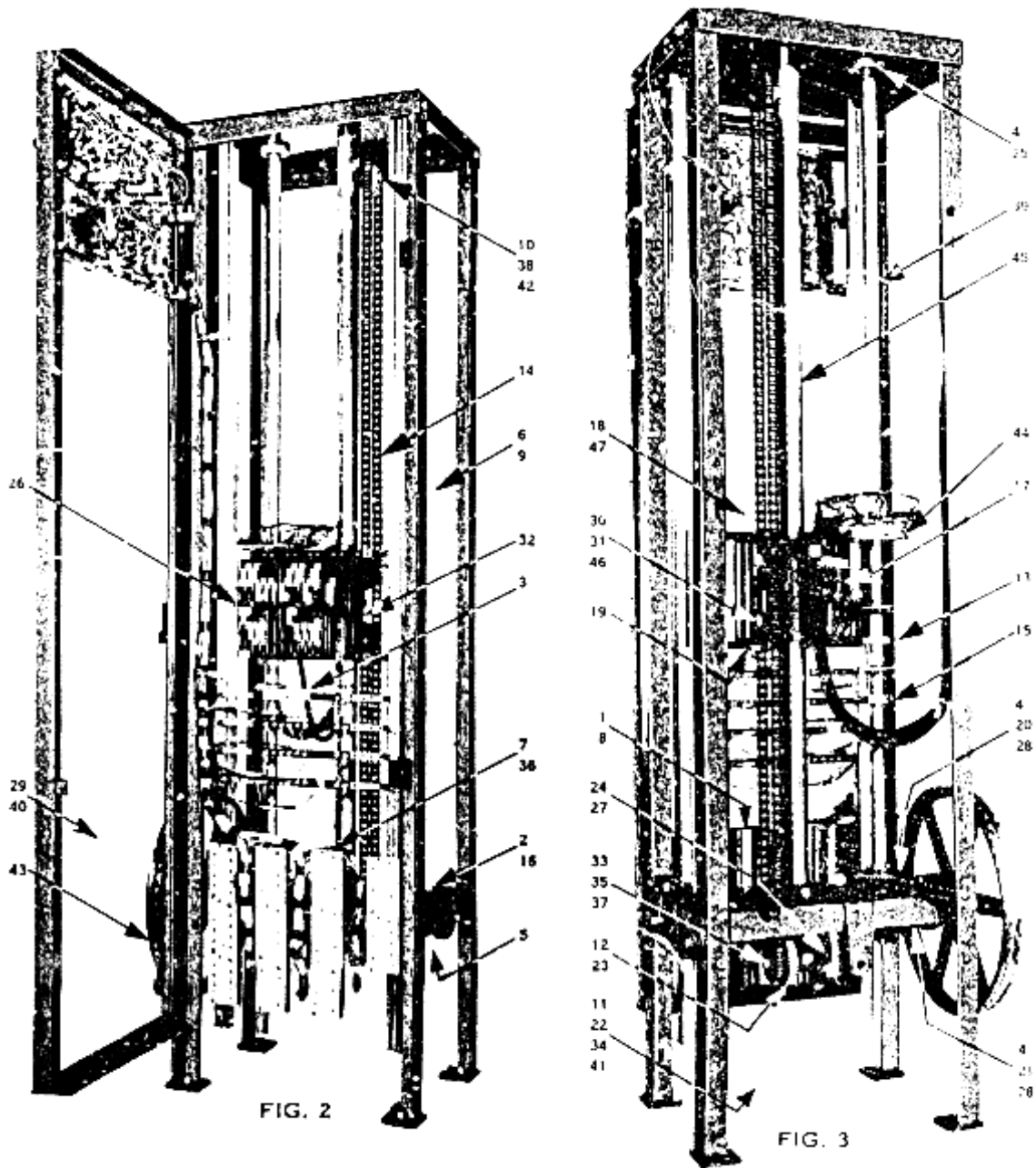

FIG. 1

FRONT VIEW
(COVER REMOVED)

1 -- 6164 SWITCHES (FOR DETAILS SEE LEAFLET C-922)

-- RESISTORS (FOR DETAILS SEE LEAFLET C-609)



C-986A - Type 6850B Selector, with type 6850AM relay panel

Page 3

PARTS FOR TYPE 6850B SELECTOR - FIG. 2 AND 3
ML 6850B1 AND ORDER FORM 0-486B

Ref. No.	Part No.	Quantity	Description
1	299TP9	2	Bar, Support, 12-3/4" long
2	306DK1	1	Base, with Oil Hole Cover (for RH Selector)
2	306DK4	1	Base, with Oil Hole Cover (for LH Selector)
3		-	Bar, Floor (for details, see Page 4, Fig. 4)
4	207Z3	3	Bearing, Ball, 19/32" ID (for Housing #396BC2 and Base)
5 Arrow indicates location, the parts themselves not showing in the illustrations.	207AN1	1	Bearing, Ball, 1-1/8" ID (for Base)
6 Arrow indicates location, the parts themselves not showing in the illustrations.	207Z31	1	Bearing, Ball, (for Frame #374GH2)
7	303B1	3	Board, 10 Stud Terminal
-	303H1	-	Board, 18 Stud Terminal
8	65BD1	2	Bolt, Special, 1/4" diam., 3/4" long (for Support Bars)
9 Arrow indicates location, the parts themselves not showing in the illustrations.	65BH1	1	Bolt, Special Hex. Head, 1-1/8" long (for Frame #374GH2)
10	335H11	1	Bushing, Flanged, Oil-less, 5/8" ID, 7/8" OD, 1" long (for Sprocket #195CH2)
11 Arrow indicates location, the parts themselves not showing in the illustrations.	335H3	2	Bushing, Flanged, Oil-less, 3/4" ID, 1" OD, 5/8" long (for Shaft #494EV2)
12	335E3	1	Bushing, Straight, Oil-less, 3/4" ID, 1" OD, 1-7/16" long (for Gear # 205C3)
13	327DE2	-	Cam
14	A332AH2	1	Chain, 3/8" roller width, 5/8" pitch, .400" roller diam., 121-7/8" long
15	336CM1	-	Clamp (for Cam #327DE2)
16	435AK1	1	Cover, Oil Hole (for Base)
17	348H1	1	Crosshead
18 Arrow indicates location, the parts themselves not showing in the illustrations.	435AF1	1	Cup, Oil (for Crosshead #348H1)
-	385AB10	1	Disk, 1-5/16" diam. (for Shaft #A494ET2)

C-986A - Type 6850B Selector, with type 6850AM relay panel

-	-	1	Drive, Indicator (for details, see Page 6, Fig. 7)
19	374GH2	1	Frame, Crosshead Panel, with Bolt and Bearing
20	202BP1	1	Gear, Bevel, 40 teeth (for Shaft #A494ET2)
21	202BR1	1	Gear, Bevel, 54 teeth (for Shaft #494ES2 or 4)
22 Arrow indicates location, the parts themselves not showing in the illustrations.	201BS1	1	Gear, Spur Pinion, 23 teeth (for Shaft #494EV2)
23	205C3	1	Gear, Spur, and Sprocket, with Bushings, Sprocket 12 teeth, Gear 40 teeth (for Pin #77JX1)
24	201BR1	1	Gear, Spur, 82 teeth (for Shaft #494EV2)
45	385HK1	1	Guide, with Pin, 1-3/4" diam., 59-3/8" long
25	396BC2	1	Housing, Bearing (for Bearing #207Z3)
-	397Z1	1	Hub, Sprocket (for Sprocket #195AY1 - see Fig. 8)
26	269T1	2	Indicator, Floor Bar Setting (for Crosshead Panel)
-	269AF2	1	Indicator, Car to Selector Ratio 60:1
28	192E19	1	Key, 1/4" sq., 1-1/16" long (for Shaft #A494ET2)
27	192D3	1	Key, 1/4" sq., 1-1/4" long, one end round, steel (for Gear #201BR1)
28	192E20	2	Key, 1/4" sq., 1-1/4" long, ends sq., steel (for Shaft #A494ET2 and Shaft #494ES2 or 4)
29 Arrow indicates location, the parts themselves not showing in the illustrations.	192E25	1	Key, 1/4" sq., 2" long, steel (for (for Shaft #494ES2 or 4)
30	288FZ1	2	Lever (for Chain)
31	67G8	2	Nut, 3/8" Elastic Stop (for Levers)
-		1	Pack, Power (for details, see Page 5, Fig. 6B)
32		1	Panel, Crosshead (for details, see Page 4, Fig. 4)
33	77JX1	1	Pin, 3/4" diam., 3-29/32" long (for Gear #205C3)
34 Arrow indicates location, the parts themselves not showing in the illustrations.	81AX4	1	Pin, Roll, 3/16" diam., 1-3/8" long (for Shaft #494EV2)
35	81AX5	1	Pin, Roll, 3/16" diam., 1-3/4" long (for Pin #77JX1)
36	102BL1	-	Plate, Marking (for Board #303B1)

C-986A - Type 6850B Selector, with type 6850AM relay panel

-	102CD1	-	Plate, Marking (for Board #303H1)
-	274D1	1	Pointer (for Indicator #269AF2)
-	230AN1	-	Rectifier, Selenium (Blocks 20 volts, DC)
-	230AN5	-	Rectifier, Selenium (Blocks 100 volts, D C)
-	232F3	-	Resistor, 47,000 ohms
37	172DE6	1	Ring, Retaining, external (for Pin #77JX1)
38	172DE9	1	Ring, Retaining, external (for Sprocket #195CH2)
-	172DE16	1	Ring, Retaining, external (for Indicator #269AF2)
39	A494ET2	1	Shaft, Cam, 1-1/8" diam., 59" long, steel
40 Arrow indicates location, the parts themselves not showing in the illustrations.	494ES2	1	Shaft, Drive, 21-3/8" long (for RH Selector)
40 Arrow indicates location, the parts themselves not showing in the illustrations.	494ES4	1	Shaft, Drive, 21-3/8" long (for LH Selector)
41 Arrow indicates location, the parts themselves not showing in the illustrations.	494EV2	1	Shaft, Pinion, with Gear and Pin
-	90WB2	1	Spring, Compression, 5/8" OD, 1-1/2" long
42	195CH2	1	Sprocket, Chain, 12 teeth with Bushing
-	195AY1	1	Sprocket, Rim, 17 teeth (for Hub #397Z1 - see Fig. 8)
43	195DR1	1	Sprocket, Rim, Tooth Tape, 52 teeth (for Hub)
43	A195BR1 For replacement, order Sprocket #195DR1 and Hub #397Z1	1	Sprocket, Tooth Tape, 52 teeth
44	-	1	Switch, Leveling (for details, see Page 8, Fig. 9)
-	-	-	Tightener, Chain (for details, see Page 6, Fig. 8)
45	A135AP5	1	Tube, with pin, 1-3/4" diam., 59-3/8" long
46	131P2	2	Washer, 7/16" ID, 1" OD, 5/16" thick, steel (for Levers)
47 Arrow indicates location, the parts themselves not showing in the illustrations.	488B2	1	Wick, 3" wide, 7-7/16" long, 1/8" thick, felt (for Crosshead)

- No longer available, for replacement order Guide #385HK1

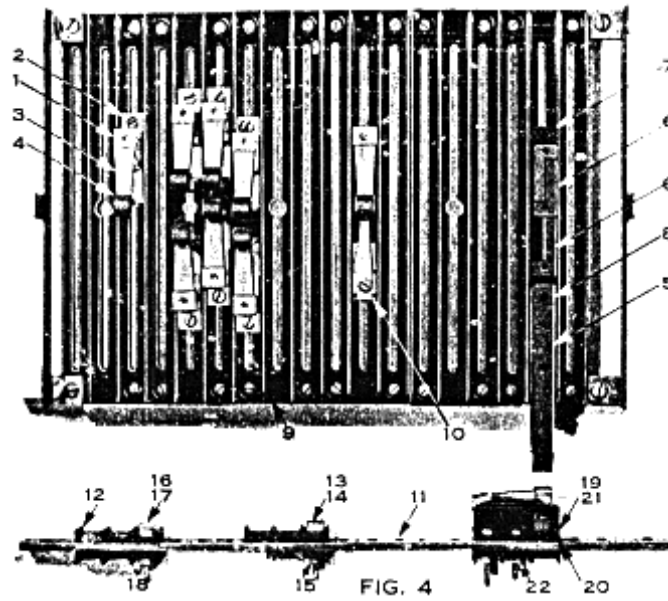

C-986A - Type 6850B Selector, with type 6850AM relay panel

PARTS FOR CROSSHEAD PANEL - FIG. 4
ML 2031AD - OR ORDER FORM 0-486B-

Ref. No.	Part or ML No.	Quantity	Description
1	A6839F3	-	Brush, Contact, each consisting
			<i>This Brush was redesigned in February 1954; for replacement of Brush or parts furnished prior to February 1954 (other than the carbon contact, which remains the same), order a complete new Brush.</i>
			of:
2			1 - Bracket part # 316BFV1
3			1 - Contact, assembled
			part # 156J4
4			1 - Contact, carbon (for Contact
			#156J4) part # 156J2
<i>Not illustrated.</i>	6482C2	1	Brush, Plunger, consisting of:
			1 - Contact part # A151C2
			1 - Guide part # A385EG1
			1 - Nut part # 72BH1
			1 - Spring part # 90KA2
5	6850E1	-	Cam, Short, each consisting of:
6			1 - Cam, 11/16" long, phenolic
			part # 327CY1
7			1 - Cam, 1-1/16" long, phenolic
			part # 327CX1
8			1 - Contact, 4" long, carbon
			part # 156F2
5	6850E2	-	Cam, Long, each consisting of:
6			1 - Cam, 1-3/16" long, phenolic
			part # 327CY2
7			1 - Cam, 1-9/16" long, phenolic
			part # 327CX2
8			1 - Contact, 4" long, carbon
			part # 156F2
5	6850E5	-	Cam, Long, each consisting of:
6			2 - Cam, 1-3/16" long, phenolic
			part # 327CY2
7			1 - Cam, 1-9/16" long, phenolic
			part # 327CX2
8			1 - Contact, 4" long, carbon
			part # 156F2
9	438CD1	-	Panel, Crosshead
10	6839H1	-	Switch, Brush (for details, see
			Page 5, Fig. 5)
<i>Not as illustrated in Fig. 4;</i>	6839Y4	1	Switch, Brush (for details, see
			Page 5, Fig. 6A)

C-986A - Type 6850B Selector, with type 6850AM relay panel

11	299NJ2	-	Bar, Floor, Flat Strip
-	A299NJ2	-	Bar, Floor, "U" shape
12	306DP1	-	Base, Floor Bar, 1-7/8" long (for Bar #299NJ2)
-	306GD1	-	Base, Floor Bar, 1-7/8" long (for Bar #A299NJ2)
-	306GD3	-	Base, Floor Bar, 1-1/4" long (for Bar #A299NJ2)
13	6850F1	-	Contact, each consisting of:
14			1 - Contact, Silver Inlay, 1-5/16" long OA part # 156E2
15			1 - Tube part #137E5 (for Bar #299NJ2)
-	153E3	-	Contact, Silver Inlay, 1-1/2" long (for Bar #A299NJ2)
16	6850F2	-	Contact, each consisting of:
17			1 - Contact, Silver Inlay, 1-35/64" long OA part # 156G4
18			1- Tube part #137E5 (for Bar #299NJ2)
-	156G4	-	Contact, Silver Inlay, 1-35/64" long OA (for Bar #A299NJ2)
19	6850F3	1	Contact, consisting of:
20			1 - Separator part #464BG1
21			1 - Switch, Brush (for details, see Page 5, Fig. 6) part #6839B1
22			2- Tubes part #137E5 (for Bar #299NJ2)
-	6839B3	1	Switch, Brush (for details, see Page 5, Fig. 6) (for bar #A299NJ2)

N.B. It should be understood that the arrangement of Switches, Brushes and Contacts on the Floor Bar and Panels shown in Fig. 4 is purely illustrative. In actual practice, the number and arrangement of the various parts depend on many things, such as car speed, number of stops, type of control etc.

C-986A - Type 6850B Selector, with type 6850AM relay panel

Page 5

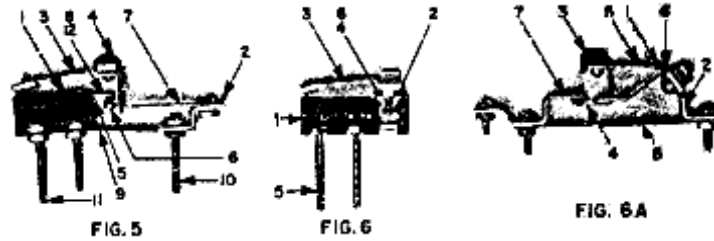

PARTS FOR BRUSH SWITCH - FIG. 5
ML 6839H1

Ref. No.	Part No.	Quantity	Description
1	306DN2	1	Base, Contact
2	316AXP1	1	Bracket
3	156J3	1	Contact, assembled
4	156J2	1	Contact, carbon (for Contact #156J3)
5	150R8	1	Contact, Spring, silver
6	150P4	1	Contact, Spring, silver
7	93D2	1	Spring, Flat (for Contact #150P4)
8	477BT1	1	Stop
9	298CH1	1	Strip, Insulating
10	97C2	1	Stud, Terminal, 1-3/8" long
11	97C1	1	Stud, Terminal, 1-3/4" long
12	131BK1	1	Washer

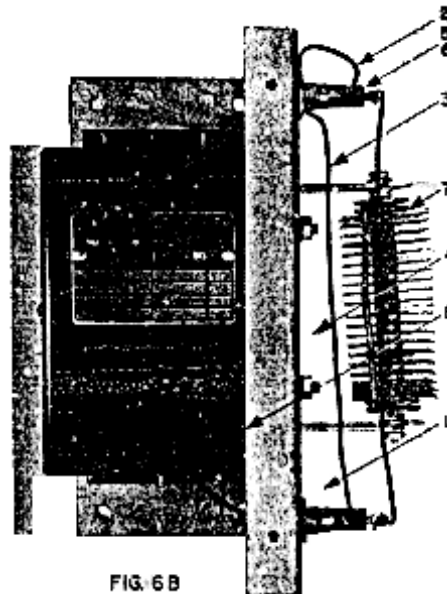

C-986A - Type 6850B Selector, with type 6850AM relay panel

PARTS FOR BRUSH SWITCH - FIG. 6

ML 6839B1- (STUD 1-3/4" LONG)

ML 6839B3- (STUD 1-7/8" LONG)

Ref. No.	Part No.	Quantity	Description
1	306DN1	1	Base, Contact
2	150R8	1	Contact, Spring, silver
3	156G2	1	Contact, assembled, silver
4	477BT1	1	Stop
5	97C1	1	Stud, Terminal, 1-3/4" long
5	97C13	1	Stud, Terminal, 1-7/8" long
6	131BK1	1	Washer

PARTS FOR TYPE 6839Y SWITCH - FIG. 6A

ML 6839Y4: WITH CARBON CONTACTS

Ref. No.	Part No.	Quantity	Description
1	6839Y2	1	Switch, consisting of:
2			1 - Bracket part #316BFV1
3			1 - Contact, carbon part # 156J2
4			1 - Contact, Movable part # 150T3
5			1 - Spring, Flat part # 93CC1
6			1 - Washer, Lock part # 130W3
7	150BA7	1	Contact, Stationary
8	298EN1	1	Strip, phenolic

PARTS FOR TYPE 6850BC POWER PACK - FIG. 6B

ML 6850BC1 AND ORDER FORM 0-466B-2

Ref. No.	Part No.	Quantity	Description
1*	334H3	1	Bushing, 11/16" ID, 1-3/16" OD, 3/8" thick, rubber
2	175BA50	1	Conductor, 12-1/4" long
3	175BA47	1	Conductor, 18" long
4*	285B1	1	Cover, Formed
5*	375P1	2	Fuse, 1 Amp.
6	180AA1	2	Holder, Fuse
7	230AY3	1	Rectifier, Selenium, 45 watts
8	A225DF3	1	Transformer, 115 volts
8	A225DF1	1	Transformer, 190,240 volts
8	A225DF2	1	Transformer, 380,440 volts
8	A225DF4	1	Transformer, 550,575 volts

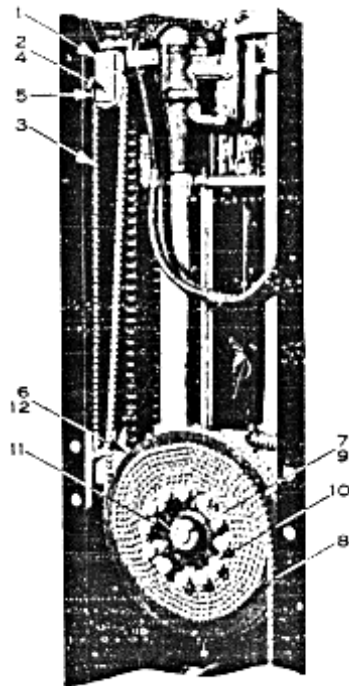

FIG. 7

C-986A - Type 6850B Selector, with type 6850AM relay panel

PARTS FOR TYPE 6850Z INDICATOR DRIVE - FIG. 7

ORDER FORM 0-486B

Ref. No.	Part or ML No.	Quantity	Description
1	316AVG2	1	Bracket, with Pulley and Pin
2	335E45	1	Bushing, Oil-less, 3/8" ID, 1/2" OD, 5/8" long (for Pulley)
3	A332AG1	1	Chain, 34-7/8" long, with rod
3	A332AG3	1	Chain, 51-3/8" long, with rod
3	A332AG6	1	Chain, 103-1/8" long, with rod
-	332AJ1	1	Chain, 43-7/8" long, with rod and rivet (not illustrated)
-	332AJ2	1	Chain, 59-5/8" long, with rod and rivet (not illustrated)
4	77JH1	1	Pin, 3/8" diam., 1" long (for Bracket)
5	198R2	1	Pulley, with Bushing
6	6833B3	1	Sheave, Indicator Chain, consisting of:
7			1 - Bushing, Oil-less, 3/4" ID, 1" OD, 1-1/8" long (for Sheave) part #335H10
8			1 - Chain, 15 feet long part #332AE1
9			1 - Pin, 2-1/8" long, steel part # 77JW1
10			12 - Pin, Rung, 1-7/16" long part # 77KW1
11			1 - Ring, Retaining, external part #172DE6
12			1 - Sheave, Chain, with Bushing part # 264B2

C-986A - Type 6850B Selector, with type 6850AM relay panel

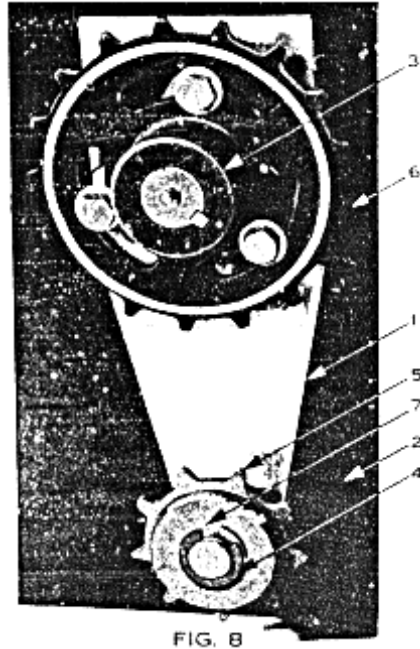

PARTS FOR TYPE 6850P CHAIN TIGHTENER - FIG. 8

ML 6850P-

Ref. No.	Part No.	Quantity	Description
1	316AXH2	1	Bracket, with pin
2 Arrow indicates location, the part itself not showing in the illustration.	335E46	1	Bushing, Oil-less, 3/4" ID, 1"
			OD, 7/8" long (for Sprocket)
3	397Z1	<i>These parts are used with the Chain Tightener but are not a part of the above Material List.</i>	Hub, Sprocket
4	172DR3	1	Ring, Retaining
5	195AZ15	1	Sprocket, 9 teeth, with Bushing
6	195AY1	<i>These parts are used with the Chain Tightener but are not a part of the above Material List.</i>	Sprocket, Rim, 17 teeth
7	127BA41	1	Washer, 49/64" ID, 1-1/4" OD,
			1/16" thick, steel

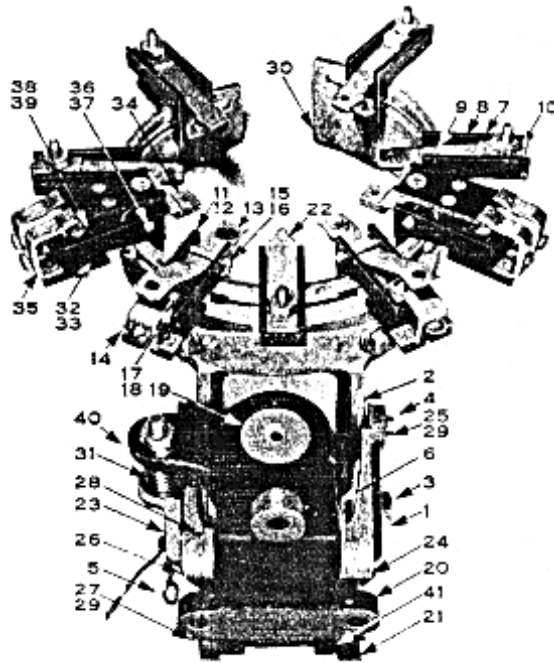

FIG. 9

C-986A - Type 6850B Selector, with type 6850AM relay panel

Page 8

PARTS FOR TYPE 6851A LEVELING SWITCH - FIG. 9

ML 6851A2, A6851A2 AND ORDER FORM 0-486B-

Ref. No.	Part or ML No.	Quantity	Description
1	.59AW1	2	Bolt, Special, Hex. Head (for Bracket to Frame #374GF2)
2	316AWM2	1	Bracket, with Bushings and Pins
3 Arrow indicates location, the parts themselves not showing in the illustration.	335E42	2	Bushing, Oil-less, 1/4" ID, 3/8" OD, 1/4" long (for Bracket)
4 Arrow indicates location, the parts themselves not showing in the illustration.	335E41	2	Bushing, Oil-less, 5/16" ID, 3/8" OD, 1/4" long (for Links)
5 Arrow indicates location, the parts themselves not showing in the illustration.	339BL1	1	Clip, Coil, brass
6	See Note	1	Coil, Magnet
7	6839D1	6	Contact, 6839D, each consisting of:
8			1 - Base, Contact part # 306CH1
9			1 - Contact, Spring, carbon part # 154AD2
10			1 - Washer part # 131BA1
11	A6839E1 This Contact (Switch) was redesigned in 1954 to use a Compression Type Spring in place of the Flat Type Spring; for replacement of the Contact or parts for Contact with the Flat Type Spring, order a complete Contact (Switch) part #A6839E1.	2	Contact (Switch), Door Zone, each consisting of:
12			1-Base, Contact part # 306FF1
13			1- Contact, Spring, Movable part # 150P37
14			1 - Contact, with base, Stationary part #A152AT1
15			1 - Pin, 1/8" diam., 19/32" long part # 77MY1
17			1 - Spring, Compression part # 90CE2

C-986A - Type 6850B Selector, with type 6850AM relay panel

19	400BB1 <i>These parts are no longer available; for replacement of either Core or Frame, order one Core part #A400BB3 and one Frame part #374GF3.</i>	1	Core, Stationary, with 13/32" diam.
			brass disk (for Frame #374GF2)
19	A400BB3	1	Core, Stationary, with 3/4" diam., brass disk (for Frame #374GF3)
20	374FW1	1	Frame, Magnet
21	374GF2 <i>These parts are no longer available; for replacement of either Core or Frame, order one Core part #A400BB3 and one Frame part #374GF3.</i>	1	Frame, with Core (for Core #400BB1)
21	374GF3???	1	Frame, with Core (for Core#A400BB3)
22	269R1	1	Indicator, Contact Setting
23	430BJ2	1	Link, with Bushing and Pin (Spring Side)
24	430BH2	1	Link, with Bushing (Opposite Side)
25	77HZ1	2	Pin, Shouldered, 3/4" long, steel (for Bracket #316AWM2)
26	79AA5	1	Pin, 5/16" diam., 2-1/2" long, brass (for Link #430BJ2)
27	77JP1	1	Pin, 5/16" diam., 2-15/32" long, steel (for Frame #374FW1)
28	81AX2	2	Pin, Roll, 3/32" diam., 3/4" long (for Pin #79AA5)
29	172ES2	4	Ring, Retaining (for Pin #77JP1 and Pin #77HZ1)
30	172ER1	1	Ring, 4-3/8" ID, steel (for Bracket)
31	90DB10	1	Spring, Compression (for Link #430BJ2)
32	A6839G1 <i>This Switch was redesigned in 1954 to use a Compression Type Spring in place of the Flat Type Spring; for replacement of the Switch or parts for Switch with Flat Type Spring, order a complete Switch part #A6839E1.</i>	2	Switch, Brush (Leveling) each
			consisting of: part#
33			1 - Base, Contact part # 306FF1

C-986A - Type 6850B Selector, with type 6850AM relay panel

34			1 - Contact, Spring, movable part #6839P1
35			1 - Contact, with base, station- ary part # 152AR2
36			1 - Pin, 1/8" diam., 19/32" long part# 77MY1
38			1 - Spring part# 90DE6
39			1 - Plate part#386ALP1
40 Arrow indicates location, the parts themselves not showing in the illustration.	131AT3	1	Washer, 9/32" ID, 5/8" OD, 1/8" thick, neoprene
41	128AF49	2	Washer, 11/32" ID, 5/8" OD, .01" thick, brass

NOTE: When ordering give part number, which will be found on Coil to be replaced; or give Sales and Serial Number of the Selector and state that it is for the Leveling Switch.

N.B. It should be understood that the arrangement of the Contacts shown in Fig. 9, is purely illustrative. In actual practice the number and arrangement of the various parts depend on many things, such as Car Speed, Type of Control etc.