

June 1, 1956

Page 1



FIG. 1

FRONT VIEW
(COVER REMOVED)

1 -- 6164 SWITCHES (FOR DETAILS SEE LEAFLET C-922)

-- RESISTORS (FOR DETAILS SEE LEAFLET C-609)

C-978B - Type 6850C Selector, with type 6850H relay panel

Page 2

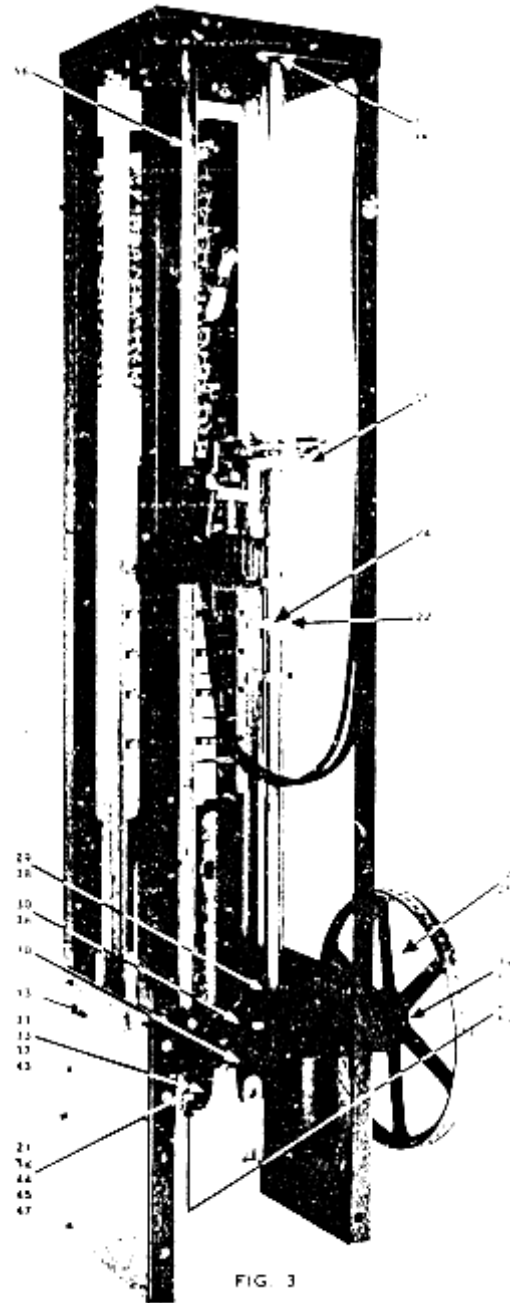
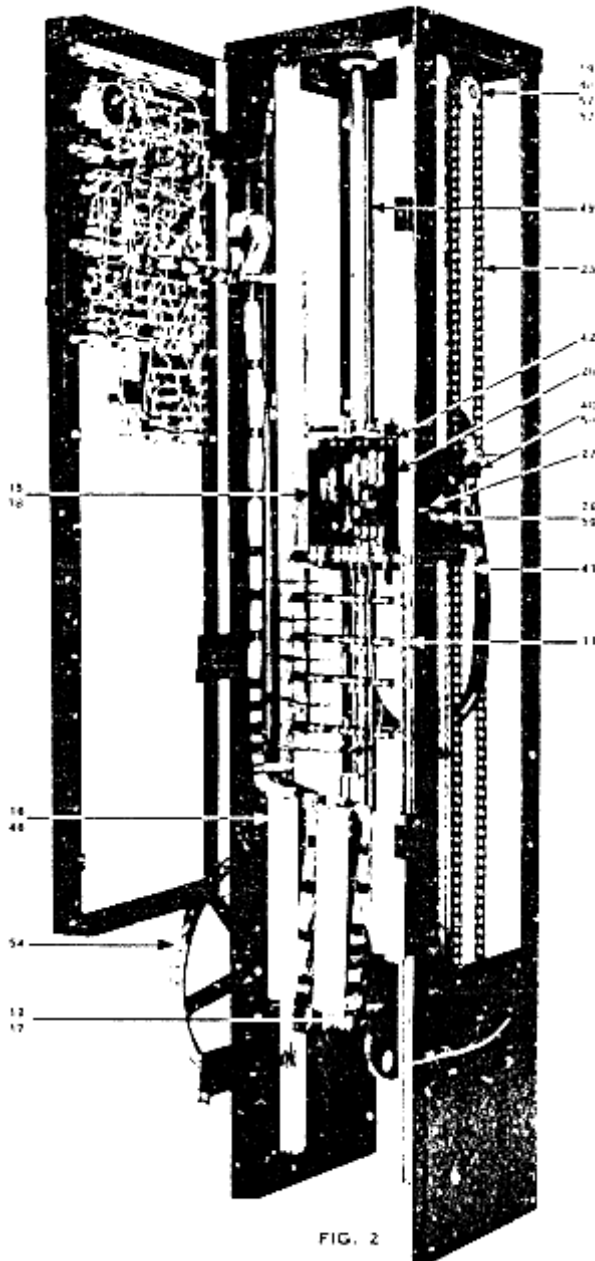

C-978B - Type 6850C Selector, with type 6850H relay panel

PARTS FOR TYPE 6850C SELECTOR - FIG. 2 & 3
ML 6850C- AND ORDER FORM 0-486

Ref. No.	Part No.	Quantity	Description
10	306DR1	1	Base, with Bushings (for RH Selector)
10	306DR4	1	Base, with Bushings (for L.H. Selector)
11	-	-	Bar, Floor (for details, see Page 5, Fig. 5)
12	299PT9	1	Bar, Support, 12-3/4" long
13 Arrow indicates location, the parts themselves not showing in the photograph.	207Z3	3	Bearing, Ball (for Housing and Base)

C-978B - Type 6850C Selector, with type 6850H relay panel

Page 3

Ref. No.	Part No.	Quantity	Description
14 <i>Arrow indicates location, the parts themselves not showing in the photograph.</i>	207AN1	1	Bearing, Ball (for Base)
15	207Z31	1	Bearing, Ball (for Frame - see Page 4, Fig. 4)
16	303B2	-	Board, 6 Stud Terminal
16	303B1	-	Board, 10 Stud Terminal
16	303H1	-	Board, 18 Stud Terminal
<i>Not illustrated;</i>	58AB3	1	Bolt, Hex. Head, 3/8" diam., 4-1/2" long (for Lever #288FZ1)
17	65BD1	2	Bolt, Special, 3/4" long (for Support Bars)
17	65BD2	2	Bolt, Special, 1-1/4" long (for Support Bar #299PT9)
18	65BH1	1	Bolt, Special, 1-1/8" long (for Frame #374GG2 - see Page 4, Fig. 4)
19	335H11	1	Bushing, Flanged, Oil-less, 5/8" ID, 7/8" OD, 1" long (for Sprocket #195CH2)
20	335H3	2	Bushing, Flanged, Oil-less, 3/4" ID, 1" OD, 5/8" long (for Base)
21	335E3	1	Bushing, Straight, Oil-less, 3/4" ID, 1" OD, 1-7/16" long (for Gear #205C3)
22	327DE2	-	Cam, Leveling
23	332AH1	1	Chain, Roller, 5/8" pitch, .400" Roller diam., 3/8" wide, 66-7/8" long
23	332AH2	1	Chain, Roller, 5/8" pitch, .400" Roller diam., 3/8" wide, 116-7/8" long
23	A332AH2	1	Chain, Roller, 5/8" pitch, .400" Roller diam., 3/8" wide, 121-7/8" long
24	336CM1	-	Clamp (for Cam)
25 <i>Arrow indicates location, the parts themselves not showing in the photograph.</i>	339CB1	4	Clip, 5/8" wide, 3/4" long, 1/16" thick (for Bearing #207AN1)
<i>Not illustrated;</i>	435AK1	1	Cover, Oil Hole (for Base)
26	348H1	1	Crosshead
27	435AF1	1	Cup, Drive-in Type, Oil (for Crosshead)
<i>Not illustrated;</i>	373AB10	1	Disk, 1-5/16" diam., (for Housing #396BC2)
-	-	1	Drive, 6850Z Indicator (for details, see Page 7, Fig. 8)
28	374GG2	1	Frame, Crosshead Panel, with Bolt and Bearing (see Page 4, Fig. 4)

C-978B - Type 6850C Selector, with type 6850H relay panel

29	202BP1	1	Gear, Bevel, 40 teeth (for Cam Shaft)
30	202BR1	1	Gear, Bevel, 54 teeth (for Drive Shaft)
31 <i>Arrow indicates location, the parts themselves not showing in the photograph.</i>	201BS1	1	Gear, Spur Pinion, 23 teeth (for Shaft #494EV2)
32	205C3	1	Gear, Spur and Sprocket, with Bushing, Gear 40 teeth, Sprocket 12 teeth (for Pin #77JX1)
33	201BR1	1	Gear, Spur, 82 teeth (for Shaft #494EV2)
34	396BC2	1	Housing, Bearing, 2-3/8" OD, 1/2" thick (for Bearing #207Z3)
35	397Z1	1	Hub, Sprocket (for Sprocket #195AY1 and #195DR1-see Page 5, Fig. 6)
<i>Not illustrated;</i>	269AF2	1	Indicator, Mechanical Stopping and Leveling Adjustment Switch
36	269T1	2	Indicator, Floor Bar Setting (for Crosshead Frame - see Page 4, Fig. 4)
37	192D3	1	Key, 1/4" square, 1-1/4" long, one end round (for Gear #201BR1)
38	192E19	1	Key, 1/4" square, 1-1/16" long, ends square (for Gear #202BP1)
38	192E20	-	Key, 1/4" square, 1-1/4" long, ends square (for Gears #202BR1 and #202BP1)
39	192E25	1	Key, 1/4" square, 2" long, ends square (for Tape Sprocket)
40	288FZ1	2	Lever, alum. (Chain to Crosshead)
41	67G8	2	Nut, 3/8" Elastic Stop (for Lever)
<i>Not illustrated;</i>	67AA1	1	Nut, Lock (for Bolt #58AB3)
-	-	1	Pack, Power (for details, see Page 8, Fig. 9 & 10)
42	-	1	Panel, Crosshead (for details, see Page 4, Fig. 4)
43 <i>Arrow indicates location, the parts themselves not showing in the photograph.</i>	81AX4	1	Pin, Roll, 3/16" diam., 1-3/8" long (for Gear #201BS1)
44	81AX5	1	Pin, Roll, 3/16" diam., 1-3/4" long (for Pin #77JX1)
45	77JX1	1	Pin, 3/4" diam., 3-29/32" long (for Gear #205C3 to Base)
46	102BL4	-	Plate, Marking (for Board #303B2)
46	102BL1	-	Plate, Marking (for Board #303B1)
46	102CD1	-	Plate, Marking (for Board #303H1)
<i>Not illustrated;</i>	274D1	1	Pointer (used with Indicator #269AF2)
47	172DE6	1	Ring, External Retaining (for Gear

C-978B - Type 6850C Selector, with type 6850H relay panel

			#205C3)
48	172DE9	1	Ring, External Retaining (for Sprocket#195CH2)
<i>Not illustrated;</i>	172DE16	1	Ring, External Retaining (for Indicator #269AF2)
49	494ET1	1	Shaft, Cam, 1-1/8" diam., 31" long O.A.
49	494ET2	1	Shaft, Cam, 1-1/8" diam., 56" long O.A.
49	A494ET2	1	Shaft, Cam, 1-1/8" diam., 59" long O.A.
50	494ES1	1	Shaft, Drive, 1-1/8" diam., 17" long (for RH Selector)
50	494ES3	1	Shaft, Drive, 1-1/8" diam., 17" long (for L.H. Selector)
50	494ES5	1	Shaft, Drive, 1-1/8" diam., 19-1/2" long (for RH Selector)
50	494ES6	1	Shaft, Drive, 1-1/8" diam., 19-1/2" long (for L.H. Selector)
51	494EV2	1	Shaft, with Gear, 3/4" diam., 4-7/8" long
<i>Not illustrated;</i>	90WB2	1	Spring, Compression, 5/8" OD, 1-1/2" long, 6 active turns (for Bolt #58AB3)
52	195CH2	1	Sprocket, Chain, 12 teeth, with Bushing
53	195AY1	1	Sprocket, Rim, 17 teeth (for Hub #397Z1 - see Page 5, Fig. 6)
54	A195BR1	1	Sprocket, Tooth Tape, 52 teeth, with hub integral
54	195DR1	1	Sprocket, Tooth Tape, 52 teeth, without hub (for Hub #397Z1)
55	-	1	Switch, Leveling (for details, see Page 6, Fig. 7)
56	135AP3	1	Tube, 1-3/4" OD, 31-3/8" long, with pin
56	135AP5	1	Tube, 1-3/4" OD, 56-3/8" long, with pin
56	A135AP5	1	Tube, 1-3/4" OD, 59-3/8" long, with pin
-	-	1	Tightener, 6850P Chain (for details, see Page 5, Fig. 6)
57	127AA25	1	Washer, Special, 21/32" ID, 1" OD, 5/64" thick (for Sprocket #195CH2)
58	131P2	2	Washer, Special, 7/16" ID, 1" OD, 5/16" thick (for Lever)
59	488B2	1	Wick, 3" wide, 7-7/16" long, 1/8" thick, felt (for Crosshead)

NOTE: Determine Hand of Selector by facing Floor Bars, if Sprocket is on the Right Side, Selector is Right Hand, on the Left Side, Left Hand.

C-978B - Type 6850C Selector, with type 6850H relay panel

@PAGE4:

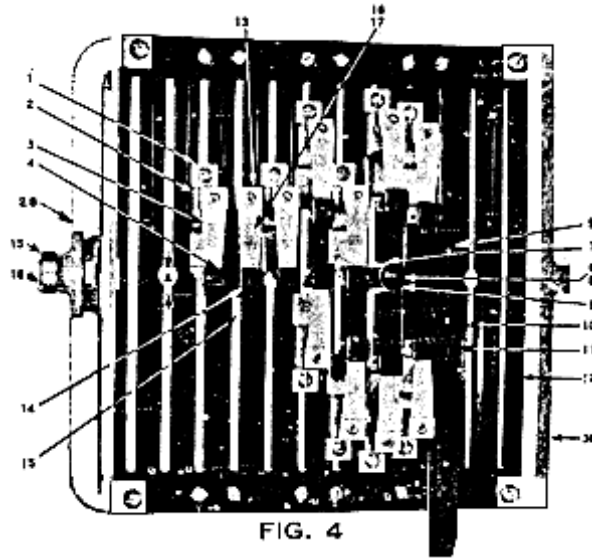

PARTS FOR CROSSHEAD PANEL - FIG. 4
ML 2031AA- OR ORDER FORM 0-486

Ref. No.	Part or ML No.	Quantity	Description	
1	A6839F2 <i>This Brush was redesigned in July 1954; to replace parts or complete Brush furnished prior to July 1954, order complete Brush #A6839F2.</i>	-	Brush, Contact, each consisting of:	
2			1 - Bracket	part #316BFV1
4			1 - Contact, carbon (A = 7/8")	part # 156D2
-			1 - Spring, Flat	part # 93CC1
-			1 - Washer, Lock	part # 130W3
1	A6839F3 <i>This Brush was redesigned in July 1954; to replace parts or complete Brush furnished prior to July 1954, order complete Brush #A6839F3.</i>	-	Brush, Contact, each consisting of:	
2			1 - Bracket	part #316BFV1
4			1 - Contact, carbon (A = 7/16")	part # 156J2
-			1 - Spring, Flat	part # 93CC1
-			1 - Washer, Lock	part # 130W3

C-978B - Type 6850C Selector, with type 6850H relay panel

5	6482C2 <i>This Brush was redesigned in October 1953; to replace parts or complete Brush furnished prior to October 1953, order complete Brush #6482C2.</i>	1	Brush, Plunger, consisting of:	
6			1 - Contact, with stud	part # A151C2
7			1 - Guide, 1-5/8" long	part #A385EG1
-			1 - Nut, Special	part # 72BH1
8	<i>Arrow indicates location, the parts themselves not showing in the photograph.</i>		1 - Spring, Compression, 1/4" ID, 9/16" long	part # 90KA2
-	6850E2	-	Cam, Long, each consisting of:	
9			1 - Cam, 1-9/16" long, phenolic	part # 327CX2
10			1 - Cam, 1-3/16" long, phenolic	part # 327CY2
11			1 - Contact, 4" long, carbon	part # 156F2
-	6850E4	1	Cam, Long, consisting of:	
9			1 - Cam, 1-1/4" long, phenolic	part # 327CX5
11			1 - Contact, 4" long, carbon	part # 156F2
-	6850E5	-	Cam, Long, each consisting of:	
9			1 - Cam, 1-9/16" long, phenolic	part # 327CX2
10			2 - Cam, 1-3/16" long, phenolic	part # 327CY2
11			1 - Contact, 4" long, carbon	part # 156F2
-	6850E1	-	Cam, Short, each consisting of:	
9			1 - Cam, 1-1/16" long, phenolic	part # 327CX1
10			1 - Cam, 11/16" long, phenolic	part # 327CY1
11			1 - Contact, 4" long, carbon	part # 156F2
-	6850E3	1	Cam, Short, consisting of:	
9			1 - Cam, 15/16" long, phenolic	part # 327CX6
11			1 - Contact, 4" long, carbon	part # 156F2
12	438CD1	-	Panel, Crosshead	
13	6839B2	1	Switch, Brush, consisting of:	
14			1 - Base, Contact	part # 306DN1
15	<i>Arrow indicates location, the parts themselves not showing in the photograph.</i>		1 - Contact, with spring, silver	part # 150R8
16			1 - Contact, assembled	part # 156J5
17			1 - Contact, carbon (for Contact #156J5)	part # 156J2

N.B. It should be understood that the arrangement of the Brushes, Cams and Switch shown in Fig. 4 is purely illustrative. In actual practice the number and arrangement of the various parts depend on many things, such as Car Speed, type of Control etc.

C-978B - Type 6850C Selector, with type 6850H relay panel

Page 5

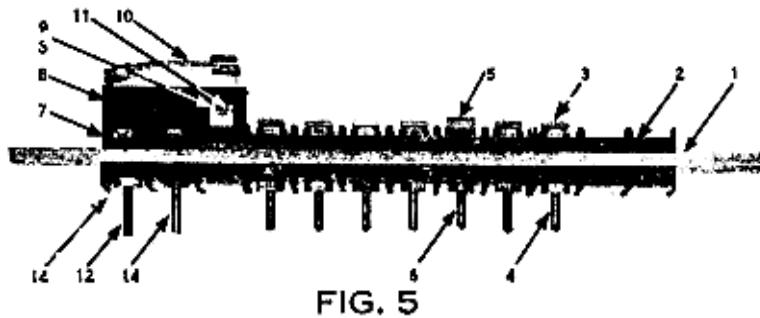

PARTS FOR FLOOR BARS - FIG. 5

ORDER FORM 0-486 OR ML 2166C-

Ref. No.	Part or ML No.	Quantity	Description	
1	299NJ1	-	Bar, Floor	
2	306DP1	-	Base, Floor Bar	
-	6850F1	-	Contact, each consisting of:	
3			1 - Contact	part # 156E2
4 Arrow indicates location, the part itself not showing in the photograph.			1 - Tube	part # 137E5
-	6850F2	-	Contact, each consisting of:	
5			1 - Contact	part # 156G3
6 Arrow indicates location, the part itself not showing in the photograph.			1 - Tube	part # 137E5
-	6850F3	1	Contact, each consisting of:	
7			1 - Separator	part #464BG1
-			1 - Switch, Brush	part #6839B1
			Consisting of:	
8			1 - Base, Contact	part #306DN1
9			1 - Contact, silver, with spring	part # 150R8
10			1 - Contact, Spring	part # 156G2
11			1 - Stop	part #477BT1
12			1 - Stud, Terminal	part # 97C1
13			1 - Washer	part #131BK1
14 Arrow indicates location, the part itself not showing in the photograph.			2 - Tubes	part # 137E5

N.B. It should be understood that the arrangement of the Contacts shown in Fig. 5 is purely illustrative. In actual practice the number and arrangement of Contacts depend on many things, such as Car Speed, Type of Control, etc.

C-978B - Type 6850C Selector, with type 6850H relay panel

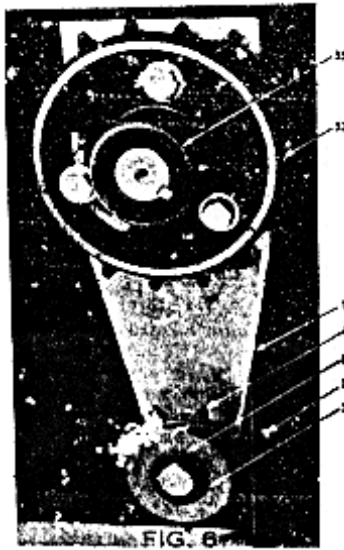

PARTS FOR 6850P CHAIN TIGHTENER - FIG. 6

ML 6850P-

Ref.	Part	Quan	
No.	No.	tity	Description
1	316AXH2	1	Bracket, with Pin
2 Arrow indicates location, the part itself not showing in the photograph.	335E46	1	Bushing, Oil-less, 3/4" ID, 1" OD, 7/8" long (for Sprocket)
3	172DR3	1	Ring, External Retaining
4	195AZ15	1	Sprocket, 9 teeth, with Bushing
5	127BA41	1	Washer, 49/64" ID, 1-1/4" OD, 1/16" thick, steel

C-978B - Type 6850C Selector, with type 6850H relay panel

Page 6

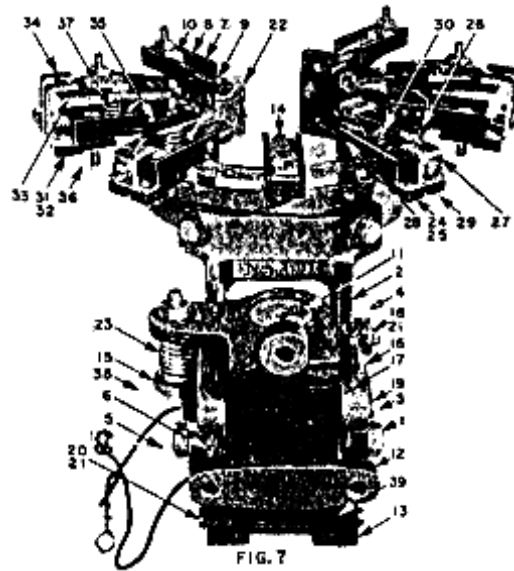

PARTS FOR 6851A LEVELING SWITCH - FIG. 7
ML A6851A- AND ORDER FORM 0-486

Ref.	Part or	Quan	
No.	ML No.	tity	Description
1	59AW1	2	Bolt, Special, Hex. Head (Bracket to Frame #374GF3)
2	316AWM2	1	Bracket, with Bushings and Pins
3 Arrow indicates location, the parts themselves not showing in the photograph.	335E42	2	Bushing, Oil-less, 1/4" ID, 3/8" OD, 1/4" long (for Bracket)
4 Arrow indicates location, the parts themselves not showing in the photograph.	335E41	2	Bushing, Oil-less, 5/16" ID, 3/8" OD, 1/4" long (for Links)
5 Arrow indicates location, the parts themselves not showing in the photograph.	339BL1	1	Clip, Coil, brass
6	See Note	1	Coil, Magnet
-	175J3	1	Conductor, 7-1/4" long (not illustrated)
-	175AS2	2	Conductor, 18" long (not illustrated)
7	6839D1	-	Contact, Brush, each consisting of:
8			1 - Base, Contact part #306CH1
9			1 - Contact, Spring, carbon part #154AD2
10			1 - Washer part #131BA1

C-978B - Type 6850C Selector, with type 6850H relay panel

11	A400BB3 <i>Stationary and Movable Magnet Cores were redesigned in July 1954; to replace Cores furnished prior to July 1954, order 1 Core part #A400BB3 and Frame with Core part #374GF3.</i>	1	Core, Stationary, with brass disk
12	374FW1	1	Frame, Magnet
13	374GF3 <i>Stationary and Movable Magnet Cores were redesigned in July 1954; to replace Cores furnished prior to July 1954, order 1 Core part #A400BB3 and Frame with Core part #374GF3.</i>	1	Frame, with core
14	269R1	1	Indicator, Contact Setting
15	430BJ2	1	Link, with Bushing and Pin (Spring Side)
16	430BH2	1	Link, with Bushing (Opposite Side)
17	81AX2	1	Pin, Roll, 3/32" diam., 3/4" long (for Pin #79AA5)
18	77HZ1	2	Pin, Shouldered, 3/4" long, steel (for Bracket #316AWM2)
19	79AA5	1	Pin, 5/16" diam., 2-1/2" long, brass (for Link #430BJ2)
20	77JP1	1	Pin, 5/16" diam., 2-15/32" long, steel (for Frame #374FW1)
21	172ES2	4	Ring, Retaining (for Pin #77JP1 and Pins #77HZ1)
22	172ER1	1	Ring, 4-3/8" ID, steel (for Bracket #316AWM2)
23	90DB10	1	Spring, Compression, 9/16" OD, 1-3/4" long, 8 active turns (for Link #430BJ2)
24	A6839E1 <i>This Switch was redesigned in July 1954; to replace parts or complete Switch furnished prior to July 1954, order complete Switch #A6839E1.</i>	-	Switch, Door Zone, each consisting
			of:
25			1 - Base, Contact part # 306FF1
26			1 - Contact, Spring, Movable part # 150P37
27			1 - Contact, with base, Station- ary part #A152AT1
28			1 - Pin part # 77MY1

C-978B - Type 6850C Selector, with type 6850H relay panel

29 Arrow indicates location, the parts themselves not showing in the photograph.			1 - Plate, Spring Support
			part # 386ALP1
30			1 - Spring, Compression, 9/32"
			OD, 5/8" long, 5-1/2
			active turns
			part # 90CE2
31	A6839G1 This Switch was redesigned in July 1954; to replace parts or complete Switch furnished prior to July 1954, order complete Switch #A6839G 1.	-	Switch, each consisting of:
32			1 - Base, Contact part # 306FF1
33			1 - Contact, assembled Movable
			part # 6839P1
34			1 - Contact, with base, Stationary part #A152AR2
35			1 - Pin part # 77MY1
36			1 - Plate, Spring Support
			part #386ALP1
37			1 - Spring, Compression, 9/32"
			OD, 5/8" long, 6-1/2
			active turns part # 90DE3
38 Arrow indicates location, the parts themselves not showing in the photograph.	131AT3	1	Washer, 9/32" ID, 5/8" OD,
			1/8" thick, rubber
39	128AF49	2	Washer, 11/32" ID, 5/8" OD,
			.01" thick, brass

NOTE: When ordering, give part number, which will be found on Coil to be replaced; or give Sales and Serial numbers of the Selector and state that it is for the Leveling Switch.

N.B. It should be understood that the arrangement of the Contacts and Switches shown in Fig. 7 is purely illustrative. In actual practice the number and arrangement of the various parts depend on many things, such as Car Speed, Type of Control etc.

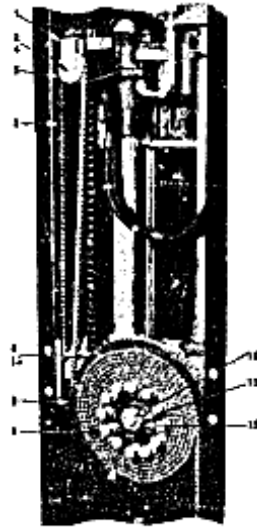

FIG. 8

C-978B - Type 6850C Selector, with type 6850H relay panel

PARTS FOR INDICATOR DRIVE - FIG. 8

ML 6850Z- AND ORDER FORM 0-486

Ref. No.	Part or ML No.	Quantity	Description	
1	316AVG2	1	Bracket, Pulley, with Pulley and Pin	
2	335E45	1	Bushing, Oil-less, 3/8" ID, 1/2" OD, 5/8" long (for Pulley #198B2)	
3	A332AG1	1	Chain, 34-7/8" long, with Rod	
3	A332AG3	1	Chain, 51-3/8" long, with Rod	
3	A332AG4	1	Chain, 55-1/8" long, with Rod	
3	A332AG6	1	Chain, 103-1/8" long, with Rod	
-	332AJ1	1	Chain, 43-7/8" long, with Rod and Rivet	
-	332AJ2	1	Chain, 59-5/8" long, with Rod and Rivet	
4	77JH1	1	Pin, 3/8" diam., 1" long (for Bracket #316AVG2)	
5	198R2	1	Pulley, with Bushing	
6	6833B1	1	Sheave, Indicator Chain, consisting of:	
7			1 - Bushing (for Sheave)	part #335H10
8			1 - Chain, 15 feet long	part #332AE1
9			12 - Pin, Rung	part # 77KW1
10			1 - Pin	part # 77JW1
11			1 - Ring, Retaining	part #172DE6
12			1 - Sheave, Chain, with Bushing	part # 264B2
13			1 - Washer	part #127VB9
6	6833B2	1	Sheave, Indicator, Chain, consisting of:	
7			1 - Bushing (for Sheave)	part #335H10
8			1 - Chain, 15 feet long	part #332AE1
9			24 - Pin Rung	part # 77KW1
10			1 - Pin	part # 77JW1
11			1 - Ring, Retaining	part #172DE6
12			1 - Sheave, Chain, with Bushing	part # 264B2
13			1 - Washer	part #127VB9
6	6833B3	1	Sheave, Indicator, Chain, consisting of:	
7			1 - Bushing (for Sheave)	part #335H10
8			1 - Chain, 15 feet long	part #332AE1
9			12 - Pin, Rung	part # 77KW1
10			1 - Pin	part # 77JW1
11			1 - Ring, Retaining	part #172DE6
12			1 - Sheave, Chain, with Bushing	part # 264B2
13			1 - Washer	part #127VB9

C-978B - Type 6850C Selector, with type 6850H relay panel

Page 8

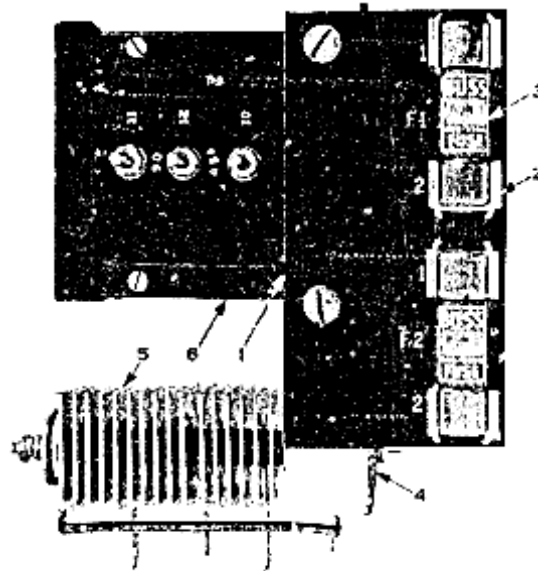

FIG. 9

PARTS FOR TYPE 6850AP POWER PACK - FIG. 9

ML 6850AP- AND ORDER FORM 0-486

Ref. No.	Part or ML No.	Quantity	Description	
1	843J-H1	1	Panel, Fuse, consisting of:	
2			4 - Clip, Fuse	part #12116
3			2 - Fuse, One-Time, 1 amp., 250 volts	part #375H1
4	105BV1	1	Plate, Base, steel	
5	230AY3	1	Rectifier, Selenium, 45 watts	
6	A225DF1	1	Transformer, 190, 240 volts	
6	A225DF2	1	Transformer, 380, 440 volts	
6	A225DF4	1	Transformer, 550, 575 volts	

C-978B - Type 6850C Selector, with type 6850H relay panel

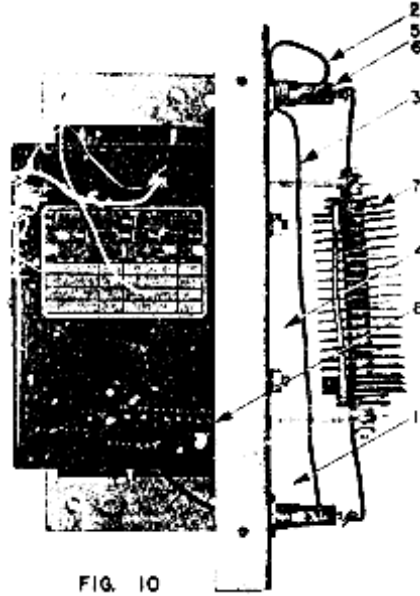

FIG. 10

PARTS FOR TYPE 6850BC POWER PACK - FIG. 10

ML 6850BC1 AND ORDER FORM 0-486

Ref. No.	Part No.	Quantity	Description
1 Arrow indicates location, the parts themselves not showing in the illustration.	334H3	1	Bushing, 11/16" ID, 1-3/16" OD,
			3/8" thick, rubber
2	175BA50	1	Conductor, 12-1/4" long
3	175BA47	1	Conductor, 18" long
4 Arrow indicates location, the parts themselves not showing in the illustration.	285B1	1	Cover, Formed
5 Arrow indicates location, the parts themselves not showing in the illustration.	175P1	2	Fuse, 1 amp.
6	180AA1	2	Holder, Fuse
7	230AY3	1	Rectifier, Selenium, 45 watts
8	A225DF1	1	Transformer, 190, 240 volts
8	A225DF2	1	Transformer, 380, 440 volts
8	A225DF4	1	Transformer, 550, 575 volts